

DS-7604NI-Q1 (D) NVR

Key Feature

- Up to 4-ch IP camera inputs
- H.265+/H.265/H.264+/H.264 video formats
- Up to 1-ch@8 MP/3-ch@4 MP/6-ch@1080p decoding capacity
- Up to 40 Mbps incoming bandwidth



Professional and Reliability

- H.265+ compression effectively reduces the storage space by up to 75%

HD Video Output

- Provide simultaneous HDMI and VGA outputs
- HDMI video output at up to 4K resolution

Storage and Playback

- 1 SATA interface for HDD connection (up to 8 TB capacity per HDD)
- Smart search/smart playback to improve the playback efficiency

Smart Function

- 1-ch Motion Detection 2.0
- Support multiple VCA (Video Content Analytics) events
- Configurable special camera smart functions, such as VCA detection (motion, line crossing, intrusion, etc.)

Network & Ethernet Access

- 1 self-adaptive 10/100 Mbps Ethernet interface
- Hik-Connect for easy network management

▪ Specification

Motion Detection 2.0	
Human/Vehicle Analysis	1-ch
Video and Audio	
IP Video Input	4-ch
Incoming Bandwidth	40 Mbps
Outgoing Bandwidth	80 Mbps
HDMI Output	1-ch, 4K (4096 x 2160)/30 Hz, 4K (3840 x 2160)/30 Hz, 2K (2560 x 1440)/60 Hz, 1920 x 1080/60 Hz, 1600 x 1200/60 Hz, 1280 x 1024/60 Hz, 1280 x 720/60 Hz
VGA Output	1-ch, 1920 x 1080/60 Hz, 1280 x 1024/60 Hz, 1280 x 720/60 Hz
Video Output Mode	HDMI/VGA simultaneous output
Audio Output	1-ch, RCA (Linear, 1 K Ω)
Two-Way Audio	1-ch, RCA (2.0 Vp-p, 1k Ω)
Decoding	
Decoding Format	H.265+/H.265/H.264+/H.264
Recording Resolution	8 MP/6 MP/5 MP/4 MP/3 MP/1080p/UXGA/ 720p/VGA/4CIF/DCIF/2CIF/CIF/QCIF
Synchronous playback	4-ch
Decoding Capability	1-ch@8 MP (30 fps)/3-ch@4 MP (30 fps)/6-ch@1080p (30 fps) *: The length or width of camera resolution (each track) cannot exceed 4096 pixels.
Stream Type	Video, Video & Audio
Audio Compression	G.711ulaw/G.711alaw/G.722/G.726
Network	
Remote Connection	32
Network Protocol	TCP/IP, DHCP, IPv4, IPv6, DNS, DDNS, NTP, RTSP, SADP, SMTP, SNMP, NFS, iSCSI, ISUP, UPnP™, HTTP, HTTPS
Network Interface	1 RJ-45 10 /100 Mbps self-adaptive Ethernet interface
Auxiliary Interface	
SATA	1 SATA interface
Capacity	Up to 8 TB capacity for each disk
USB Interface	2 x USB 2.0
Alarm In/Out	N/A (4/1 is optional)
General	
Power Supply	12 VDC, 1.5 A
Consumption	≤ 10 W (without HDD)
Working Temperature	-10 °C to 55 °C (14 °F to 131 °F)
Working Humidity	10% to 90%

Dimension (W × D × H)	320 × 240 × 48 mm (12.4" × 9.4" × 1.9")
Weight	≤ 1 kg (without HDD, 2.2 lb.)
Certification	
FCC	Part 15 Subpart B, ANSI C63.4-2014
CE	EN 55032: 2015, EN 61000-3-2, EN 61000-3-3, EN 50130-4, EN 55035: 2017

Note:

Alarm in/out can be optional for certain models. If you select a device model with "/ALARM", then the device will have 4 alarm inputs and 1 alarm output.

Dimension

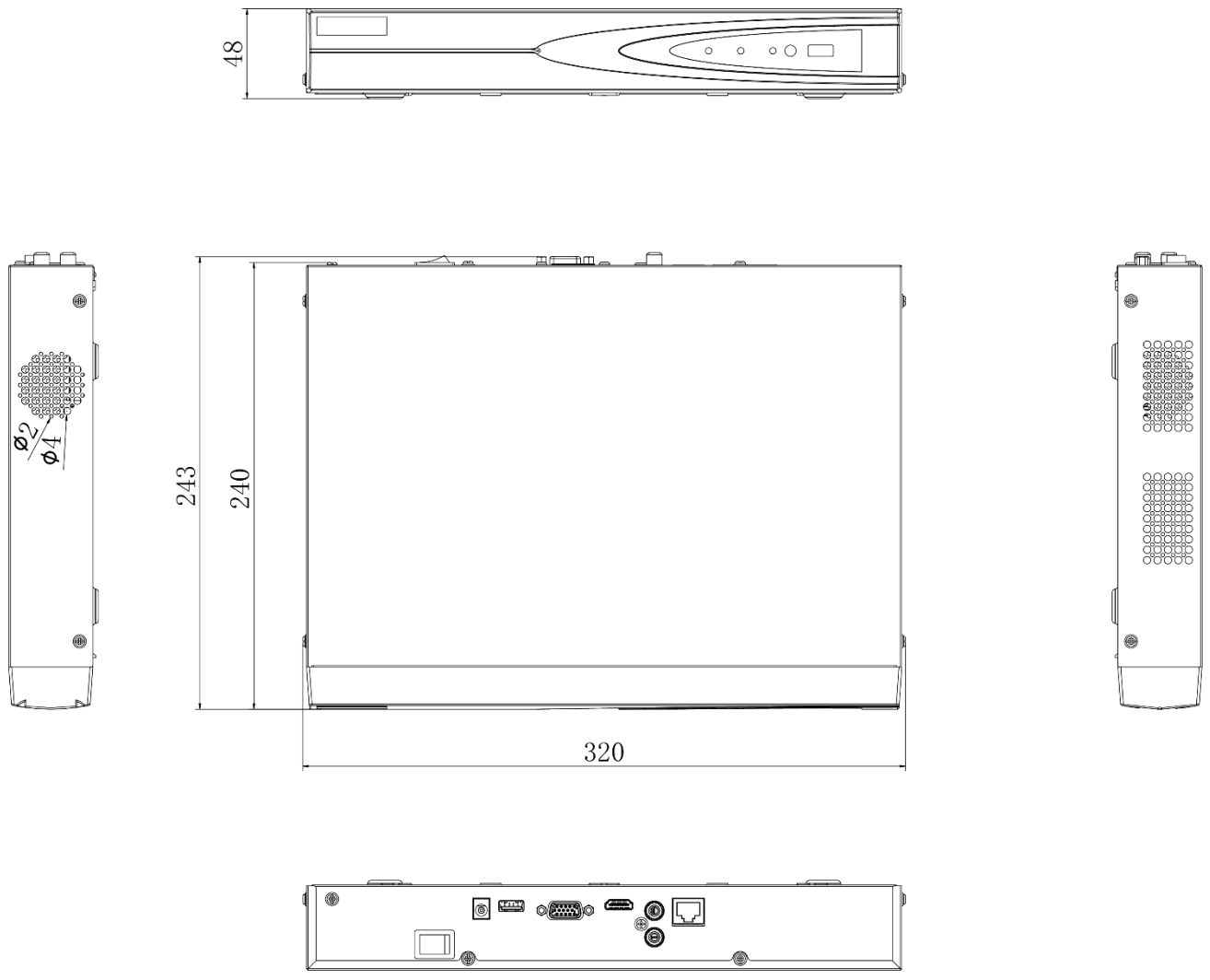

scale/1:1;Unit/mm

Physical Interface

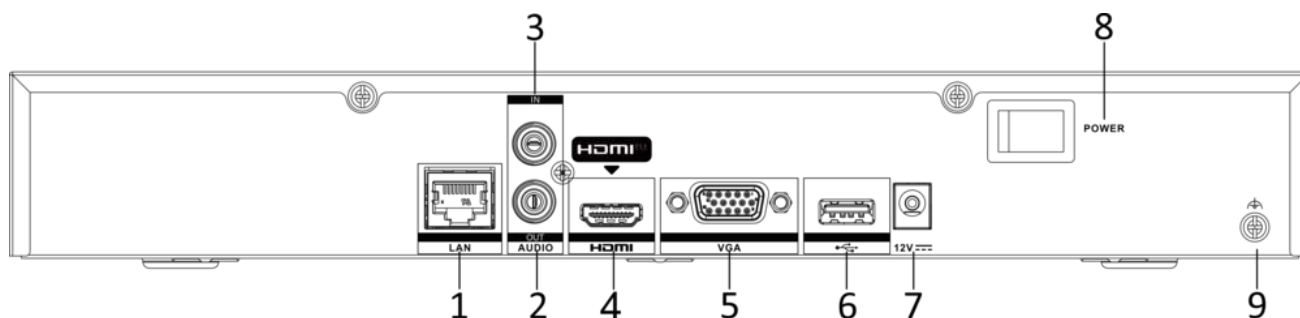

No.	Description	No.	Description
1	LAN interface	6	USB interface
2	AUDIO OUT	7	Power supply
3	AUDIO IN	8	Power switch
4	HDMI interface	9	GND
5	VGA output (DB9 connector)		

Available Model

DS-7604NI-Q1 (D)

Headquarters

No.555 Qianmo Road, Binjiang District,
Hangzhou 310051, China
T: +86-571-8807-6888
www.hikvision.com

Follow us on social media to get the latest product and solution information.

